

SSD-AL Aluminium Enclosures

The SSD-AL is an aluminium Ex d Flameproof enclosure designed to house and provide maximum protection for electrical and electronic apparatus within Zone 1 and 21 hazardous areas.

As standard the SSD-AL comes painted externally to RAL7001 Grey.



IP66



Product Specification

Apparatus Type	Flameproof Enclosure
Ingress Protection	IP66 to EN60529
Material	Enclosure: Marine Grade Aluminium (EN AB 43100) Cover: Marine Grade Aluminium (EN AW 6082) Hinges & Fasteners: 316 Stainless Steel
Mounting Plate	Galvanized Steel
Components	Switches, Breakers, RCD units, Indicator lamps, motor controllers, etc.
Voltage Rating	Up to 24kV ac or 1500V dc
Cable Entry	Variable Metric or NPT entry combinations on any of the 4 sides
Mounting	Via adjustable rear mounting feet (see dimensional data overleaf)
Certification	
Area Classification	Group IIB Category 2 GD (Zone 1/21 and 2/22), <i>Option:</i> Group IIB+ H ₂ Category 2 GD (Zone 1/21 and 2/22)
Type of Protection	Ex db (Flameproof), Ex tb (Dust), Ex db [ia/ib] (Intrinsically Safe)*
Apparatus Coding	Ex db IIB or IIB+H ₂ T* Gb, Ex tb* IIIC T* °C Db Ex db [ia Ga] IIB or IIB+H ₂ T6 Gb, Ex tb [ia Da] IIIC T85 °C Db Ex db [ib Gb] IIB or IIB+H ₂ T6 Gb, Ex tb [ib Db] IIIC T85 °C Db
Ambient Temperature	-20°C ≤ Tamb ≤ 40°C (with options for +45°C, +50°C, +55°C and +60°C)
Certificate Number	INERIS 13ATEX0019X / IECEx INE14.0061X

* - Type of protection and temperature class subject to inspection of internal components

Power Dissipation Ratings

SSD Model	Max Dissipated Power (W)**					
	T6 / T85°C		T5 / T100°C		T4 / T135°C & T3 / T200°C	
	Ta +40°C	Ta +60°C	Ta +40°C	Ta +60°C	Ta +40°C	Ta +60°C
SSD-AL224	34	22	47	31	76	49
SSD-AL425	67	44	92	60	149	97
SSD-AL446	88	57	120	78	197	128
SSD-AL456	109	71	149	97	243	158
SSD-AL566	149	97	203	132	332	216
SSD-AL656	152	99	207	135	338	220
SSD-AL666	191	124	261	170	426	277
SSD-AL667	217	141	296	192	483	314

** - Refer to certificates for full details

Enclosure Dimensions

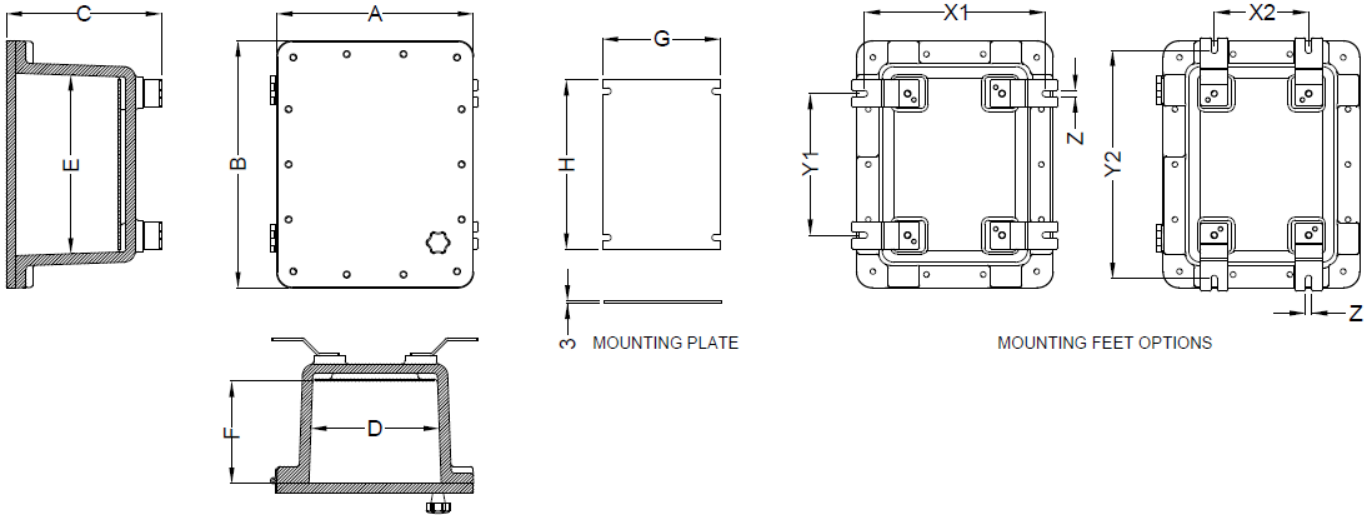

SSD Model	EXTERNAL Dimensions (mm)			INTERNAL Dimensions (mm)			FIXING Dimensions (mm)			Mounting Plate (mm)		Weight (kg)
	A	B	C	D	E	F	X1/X2	Y1/Y2	Z	G	H	
SSD-AL224	250	314	197	163	227	140	230/ 120	180/ 290	8	150	215	10
SSD-AL425	247	425	252	163	340	191	238/ 128	290/ 400	8	150	321	15
SSD-AL446	412	489	281	306	383	209	392/ 255	335/ 472	10	290	360	34
SSD-AL456	493	532	278	384	422	208	457/ 320	360/ 497	10	358	394	40
SSD-AL566	540	594	337	425	479	238	535/ 360	400/ 575	12	391	446	78
SSD-AL656	445	833	340	333	718	241	425/ 250	630/ 805	12	294	670	87
SSD-AL666	610	832	340	497	714	240	580/ 405	630/ 805	12	450	670	119
SSD-AL667	612	832	436	495	713	337	580/ 405	630/ 805	12	450	670	130

Options

H2	Group IIB+ H ₂ version
RALxxxx	Special Paint Finish (Any RAL colour) Note: Maximum paint thickness limited to 2mm for IIB and 0.2mm for IIB+H ₂ areas
W	Window options available for window fitted to cover or sides
BD	Breather Drain (Stainless Steel M20 or 1/2" NPT)

Add the required suffix to the product reference, for example SSD-AL224RAL5015